



## Roborock S6 Robotic Vacuum Cleaner Manual

Read this manual carefully before using the product and store it properly.

• Safety Information	..... 01
• Table of Faults	..... 06
• Welcome	..... 07
• Product Introduction	..... 08
• Installation	..... 13
• Instructions for Use	..... 17
• Routine Maintenance	..... 21
• Basic Parameters	..... 26
• Troubleshooting	..... 27
• FAQs	..... 29
• EU Declaration of Conformity	..... 31
• WEEE Information	..... 34
• Warranty Information	..... 35

# Safety Information

## Restrictions

- This product is designed for indoor floor cleaning only, do not use it outdoors (such as on an open-ended terrace), on any surface other than the ground (such as a sofa), or in any commercial or industrial environment.
- Do not use this product on elevated surfaces without barriers such as the floor of a loft, an open-ended terrace, or on top of furniture.
- Do not use the product when the ambient temperature is higher than 104°F (40°C), lower than 39°F (4°C), or if there are liquids or tacky substances on the floor.
- Before using the product, move wires off the ground or place them to the side to prevent them being pulled on by the cleaner.
- To prevent blocking the product and to avoid damage to valuables, remove light-weight items (such as plastic bags) and fragile objects (such as vases) from the floor before cleaning.
- Children should be supervised to ensure that they do not interfere with the product.

# Safety Information

- This product is not intended for use by persons (including children) with reduced physical, sensory or mental capabilities, or lack of experience and knowledge, unless they have been given supervision or instruction concerning use of the product by a person responsible for their safety (CB).
- This product can be used by children aged from 8 years and above and persons with reduced physical, sensory or mental capabilities or lack of experience and knowledge if they have been given supervision or instruction concerning use of the product in a safe way and understand the hazards involved. Children shall not play with the product. Cleaning and user maintenance shall not be made by children without supervision (EU).
- Keep the main brush cleaning tools out of reach of children.
- Do not place any object (including children and pets) on the product, whether it is in operation or not.
- Keep hair, loose clothing, fingers, and all parts of the body away from openings and moving parts.

# Safety Information

- Do not use the product on burning objects (such as cigarette butts).
- Do not use the product on high pile carpets (product effectiveness may also be reduced on dark carpets).
- Do not use the product to clean hard or sharp objects (such as decoration wastes, glass and nails).
- Do not carry the product using the laser scanner cap, main unit cover, or collision buffer.
- The product must be switched off and the plug must be removed from socket-outlet before cleaning or maintaining the product.
- Do not use wet cloth or liquids for cleaning the product.
- Do not use the mopping module on carpets.
- Use the product according to the manual. Any loss or damage caused from improper use will be borne by the user.
- This product contains batteries that are only replaceable by skilled persons.

# Safety Information

## Battery and Charging

### WARNING

- Do not charge non-rechargeable batteries.
- For the purposes of recharging the battery, only use the detachable supply Unit Roborock CDZ08RR or CDZ09RR provided with this product.
- Do not dismantle, repair or modify the battery or charging dock.
- Keep the charging dock away from heat (such as heating vents).
- The battery must be removed before disposing the product.
- The product must be disconnected from the supply mains when removing the battery.
- The battery must be disposed of safely. Do not discard waste batteries. Leave them with a professional recycling organization.
- Do not wipe or clean the charger prongs with wet cloth or wet hands.
- If the power cord is damaged, stop using it immediately. It must be replaced by the manufacturer, its service agent, or similarly qualified persons to avoid a hazard.

# Safety Information

- Make sure the product is powered off before shipment.  
Use of the original packaging is advised.
- If to be left unused for a long period of time, fully charge the product and switch it off before storing it in a cool, dry place.
- Charge it at least every three months to avoid over discharging the battery.

## Table of Faults

Table of Faults	
Item	Fault
Main Unit	Functions do not work.
	Does not power on.
	Main brush, side brush, fan or main wheel issue.
Charging dock	Main unit does not charge.
Power cable	Charging dock has no power.



# Welcome

---

Thank you for choosing a Roborock S6 Robotic Vacuum Cleaner.

This product is a sweeping and mopping robot equipped with a high-precision laser guided navigation system that allows it to quickly and accurately create and store a map of every room of your home. Using this map, an advanced dynamic route planning system plans out the most efficient path for cleaning each of your rooms as quickly as possible. You can check this map, as well as the location of the product, and the progress of any clean, using the Xiaomi Home App, which also lets you schedule cleans and take control remotely. If for any reason you can't use your phone, you can also control it using a variety of voice commands.

Through powerful sweeping and mopping systems inspired by nature, your floors are treated to a thorough clean and deep dirt removal every time you clean. After a clean, it automatically drives back to the charging dock to recharge, without out any help from you. Best of all, new noise reduction designs give you all the power with less of the noise so you can any time in the day or night without disruption.

Roborock is dedicated to putting the most advanced technologies to work making your life easier. With your new Roborock S6 product doing the hard work, you can focus on doing the things you truly enjoy.

Roborock

# Product Introduction

## Main Unit

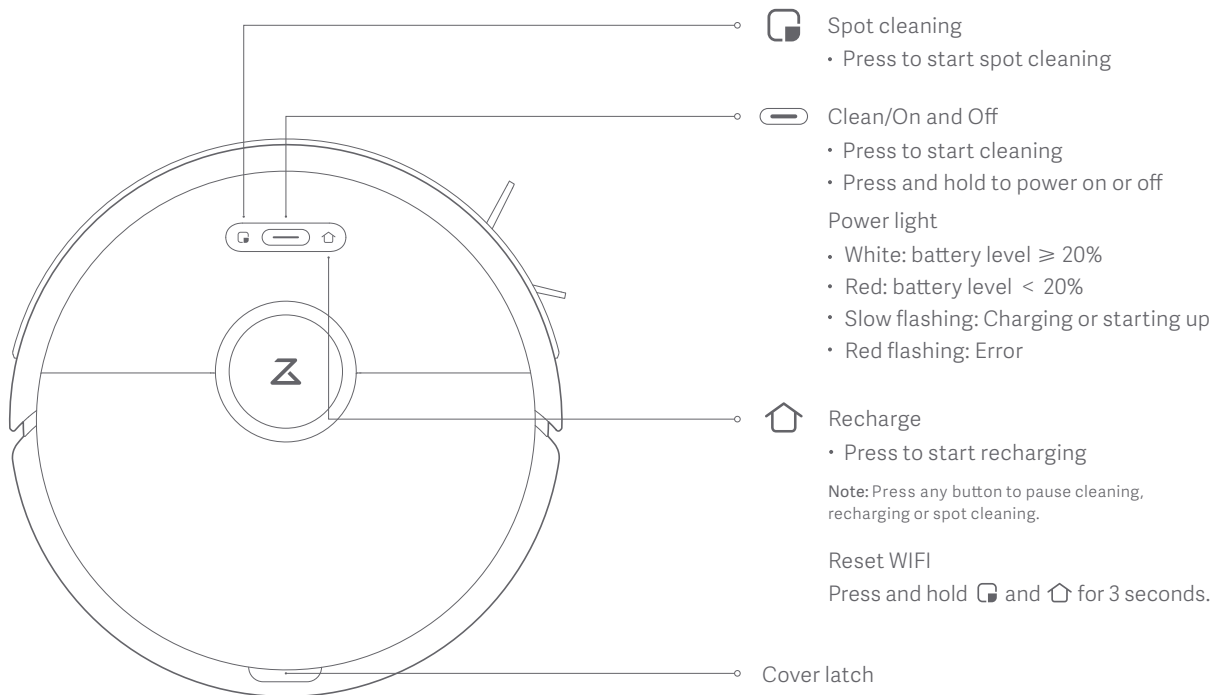

# Product Introduction

## Part list



Adjustable water tank



Mop cloth

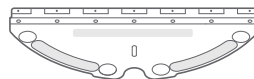

Mounting plate –  
disposable mop cloth



Disposable mop cloth



Air filter

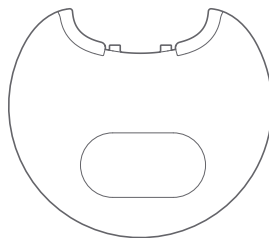

Damp-proof mat



Water filter

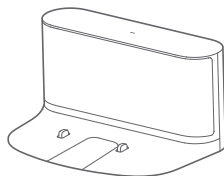

Charging dock

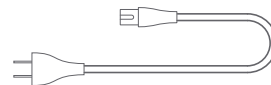

Power cable

# Product Introduction

## Dustbin

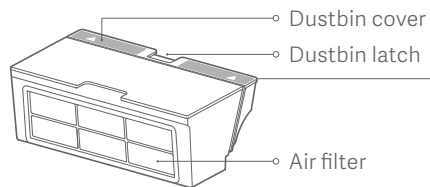

## Main Unit

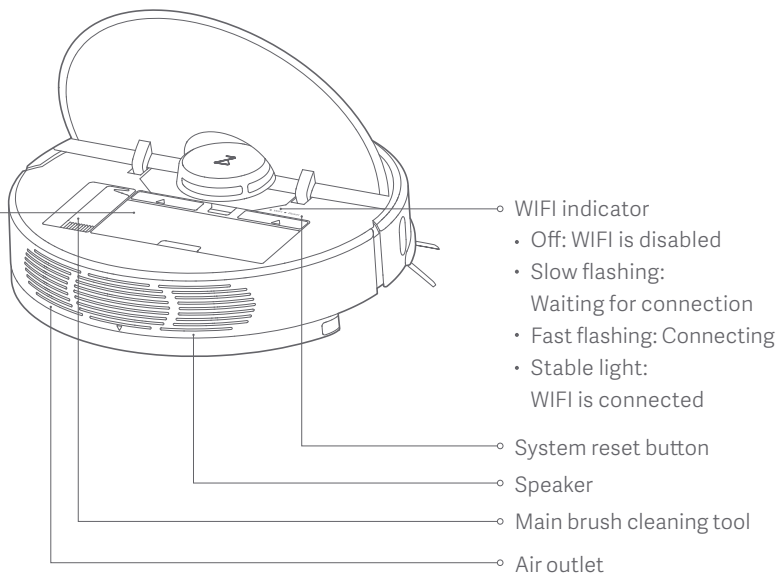

# Product Introduction

## Main Unit and sensor

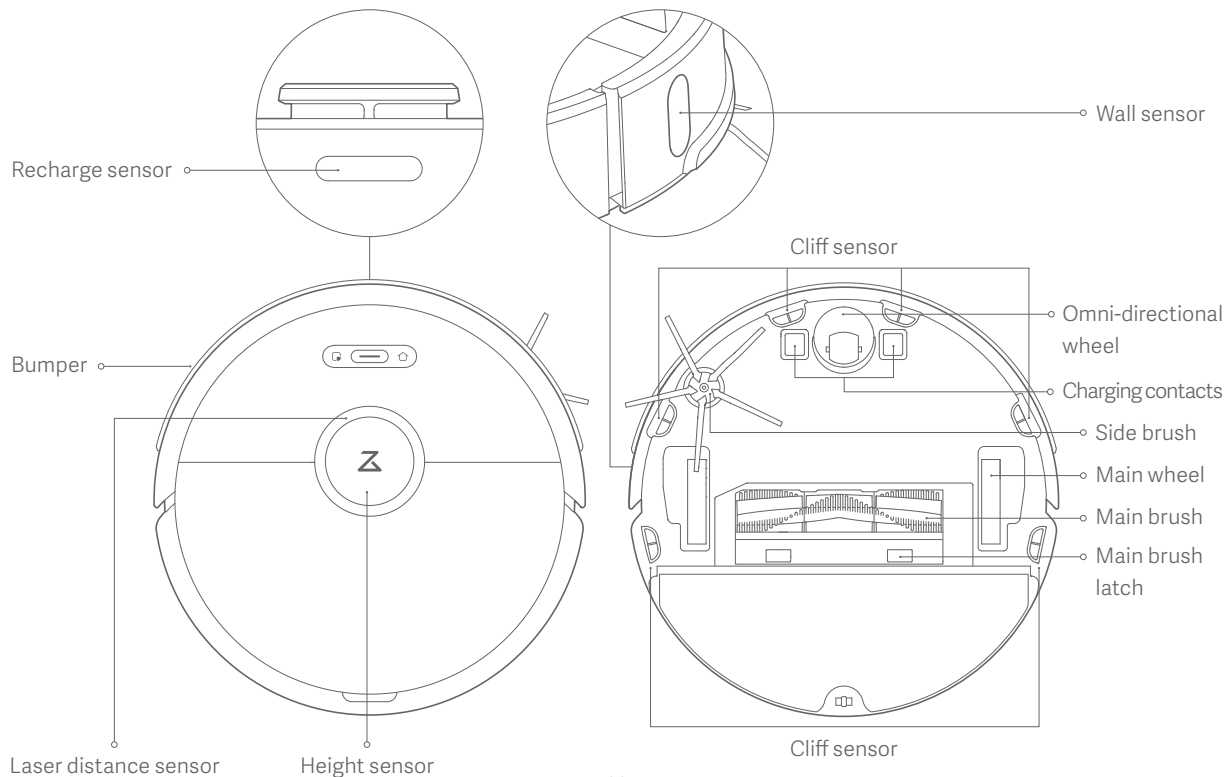

# Product Introduction

## Mopping module

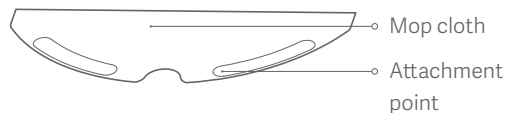
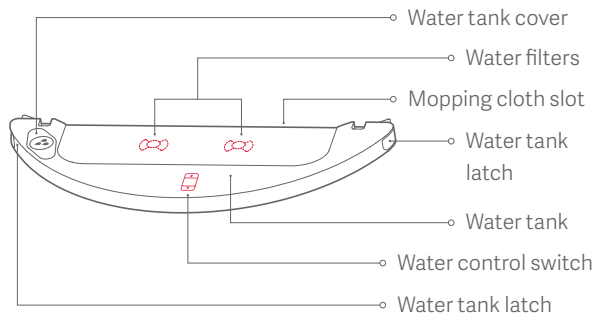

## Charging Dock

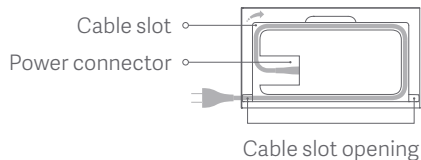
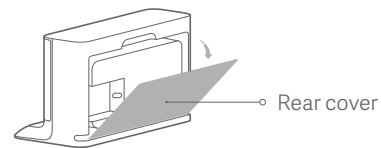
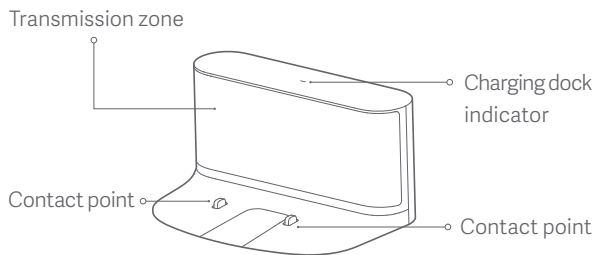

# Installation

## Setup

1. Clip the damp-proof mat onto the charging dock using the guiding grooves.

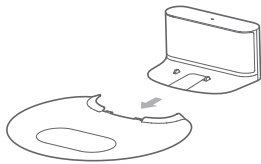

2. Place the charging dock against a wall on a level floor and plug it in. Hide any excess cable in the cable slot.

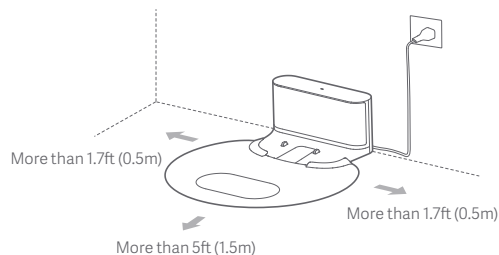

### Notes:

- Keep at least 1.7ft (0.5m) on either side and 5ft (1.5m) in front of the charging dock clear.
- If the power cable is left hanging vertically, it may get caught as the main unit cleans, causing it to loosen or unplug.
- The charging dock indicator will be lit when the dock is plugged in, and off when the main unit is charging.

3. Power on and charge.

Press and hold the  button to power on, wait until the ring light turns on, and then place the main unit onto the charging dock to charge. The high-performance lithium-ion rechargeable battery pack inside must be charged regularly to maintain optimum battery performance.

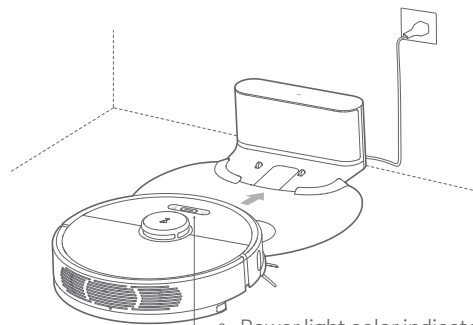

Power light color indicates battery level

- White: Battery level  $\geq$  20%
- Red: Battery level  $<$  20%

**Note:** The product will not power on if the battery is low. Place the main unit directly onto the charging dock to recharge.

4. Connect with Xiaomi Home App. (Optional)

# Installation

This product works with Xiaomi Home app . Control your device, and interact it and other smart home devices with Xiaomi Home app.

## Quick Setup

### ① Download Xiaomi Home app

Scan the QR code to download and install the app. You will be directed to the connection setup page if the app is installed already. Or search "Xiaomi Home" in the app Store to download and install it.



Note: For specific connection instructions, visit the Roborock website and download guidelines for iOS and Android devices.

### ② Add Device



Open Xiaomi Home app, tap "+" on the upper right, and then follow prompts to add your device.

\* The app is referred to as Xiaomi Home app in Europe (except for Russia). The name of the app displayed on your device should be taken as the default.

Note: The version of the app might have been updated, please follow the instructions based on the current app version.

WiFi connection only supports networks in the 2.4 GHz band, not the 5 GHz band.

### ③ Reset WIFI

If you experience any WIFI problems, reset the WIFI to defaults. Open the top cover to expose the WIFI indicator then press and hold the  button and the  button until you hear the "Reset WIFI" voice prompt. Reset is complete when the WIFI indicator flashes slowly. The product will then wait for a connection.

Note: If a mobile phone has never been connected to the product, or if there is a problem with the connection, reset the WIFI before attempting connection.

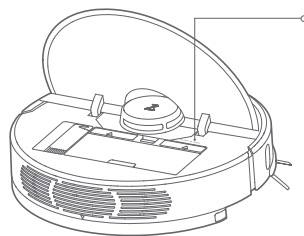

- WIFI indicator
- Off: WIFI is disabled
- Slow flashing: Waiting for connection
- Fast flashing: Connecting
- Stable light: WIFI is connected



# Installation

## Using the mop

5. Install the mopping module.

① Adjusting the water flow rate

Adjust the water flow rate according to your preferences.

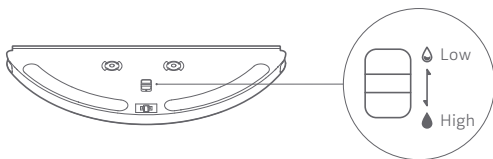

② Install the mop cloth

a. Installing a reusable mopping cloth

Dampen the mop cloth and squeeze it dry. Slot it into the mounting point and slide it along the groove on the water tank then press it firmly in place.

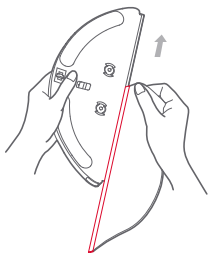

Note: Use barrier tapes to create a border around carpets.

b. Installing a disposable mop cloth

b1. Installing the disposable mop cloth plate

Insert the disposable mop cloth plate from right to left along the slot on the water tank as shown then press it firmly in place.

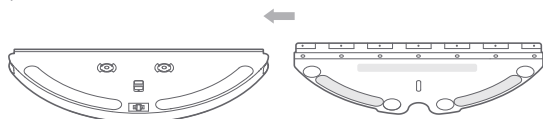

Disposable mop cloth plate

b2. Securing a disposable mop cloth

Place the water tank on a flat surface with the disposable mopping cloth fabric facing up. Align the cloth with the mop cloth plate and press it down firmly. Press down on the various locking points to secure the cloth onto the mop cloth plate.

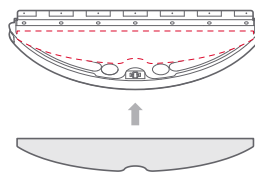

Disposable mop cloth

# Installation

## Using the mop

### ③ Refill the water tank

Open the water tank, fill the tank with water, then reseal it carefully.

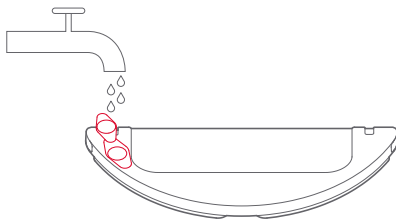

**Note:** Some floor cleaners or disinfectants may block the water filters.

### ④ Install the mopping module

Line the mopping module up with the alignment indicators on the rear of the Main Unit then slot it in until you hear a click.

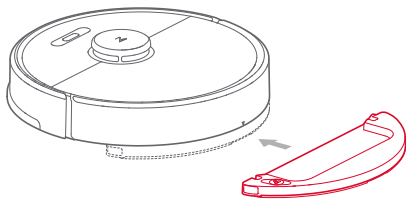

### 6. Start cleaning

When the power light changes from a slow white flash to a steady light, charging is complete. Press the  button or use the Xiaomi Home app to start cleaning.

### 7. Remove the mopping module

When a cleaning cycle is complete and the main unit has returned to the charging dock, press the latches on either side of the mopping module and pull backwards to remove it.

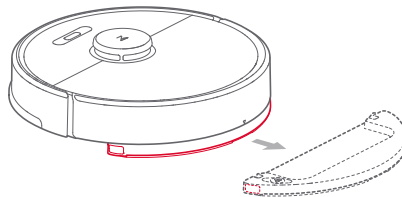



#### Notes:

- Remove the mopping module if the product is to be left unused. Empty any water left in the water tank and clean the mopping cloth to prevent mildew or odors.
- If the charging dock is placed on a wood floor, always use the damp-proof mat to avoid moisture leaking to the floor.

# Instructions for Use

## On / Off

Press and hold the  button to power on the main unit. The power light will turn on and the main unit will enter standby mode. When the main unit is idle, press and hold the  button to power off and end the current cleaning cycle.

**Note:** The main unit cannot be shut down during charging.

## Start cleaning

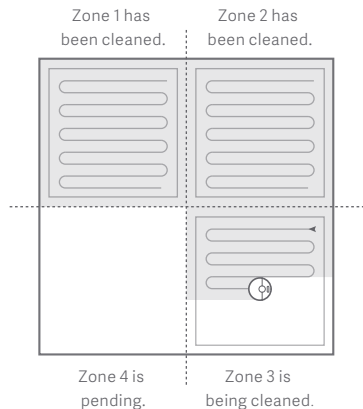

Press the  button to start cleaning. When cleaning, the product will plan an appropriate cleaning path based on the generated map of the scanned area. It will clean along the edges of a zone first and then plan a Z-shaped cleaning route to cover the whole zone efficiently and quickly without missing a spot.



### Notes:

- Cleaning cannot be started if the battery level is too low. Recharge battery then restart cleaning.
- Tidy away cables (including the charging dock power cable) from the floor before cleaning to avoid power failure and to prevent damage resulting from a dragged cable.
- If a cleaning cycle is completed within 10 minutes, by default, cleaning will repeat.

## Pause

When the product is running, press any button to pause it. Press the  button to restart cleaning or the  button to end the cleaning cycle and send the product back to the charging dock.

**Note:** Docking the main unit to the charging dock when paused will stop the current cleaning cycle.

## Sleep

If inactive for more than 10 minutes, the product will enter sleep mode and its indicator light will flash slowly. Press any button to wake the product.

### Notes:

- The product will not enter sleep mode when connected to the charging dock.
- The product will automatically shut down if left in sleep mode for over 12 hours.

# Instructions for Use

## Charge

**Auto mode:** After cleaning, the main unit will automatically return to the charging dock for charging.

**Manual mode:** In pause mode, press the  button to start recharging. The power light flashes slowly when the robot is being charged.

**Note:** If failing to find the dock charger, the main unit will automatically return to its starting point. Manually place the main unit onto the charging dock for charging.



## Errors

If an error occurs, the power light will flash red quickly and a voice prompt will sound. Refer to “Troubleshooting” for solutions.

### Notes:

- The product will automatically enter sleep mode after 10 minutes of inactivity in an error state.
- Docking the main unit to the charging dock in an error state will stop the current cleaning cycle.

## Reset WIFI

If your smartphone cannot connect to the product for any reason, open the dustbin cover to view the WIFI indicator then press and hold the  button and the  button until you hear the “Reset WIFI” voice prompt. Reset is complete when the WIFI indicator flashes slowly.

**Note:** WIFI will be automatically disabled if it takes over an hour to connect. If you need to reconnect, reset the WIFI before proceeding.

## Spot cleaning

In standby or pause mode, press the Spot Cleaning button to start spot cleaning. This mode cleans a 16.4ft (1.5m) square area centered on the product. After cleaning, it will return to its starting point.

**Note:** Starting spot cleaning in pause mode will stop the current cleaning cycle.

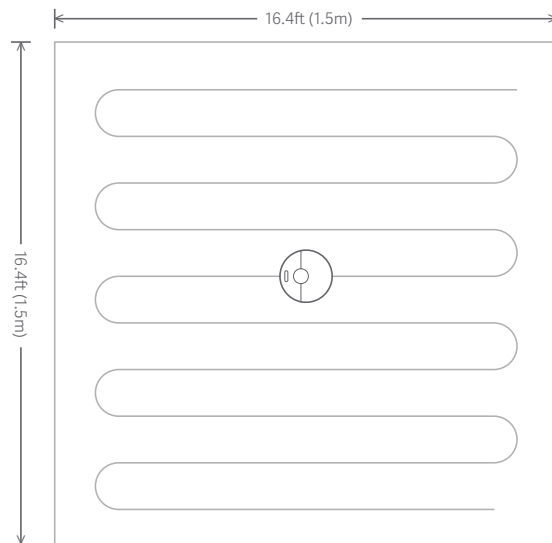

## Instructions for Use \* The following features can be activated in the App

### Room cleaning

Send the product to clean specific rooms of your home.

Note: Map saving must be switched on to use Room cleaning.

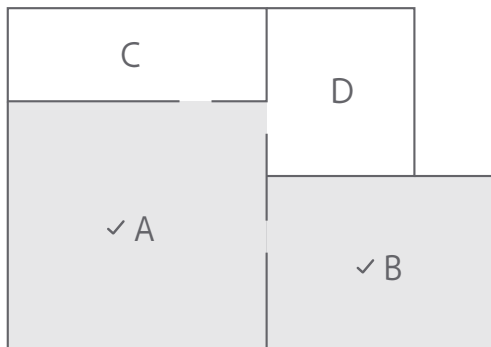

### Scheduled cleaning

Schedule when you want the product to start cleaning. After cleaning, it will return to its charging dock.

Note: Scheduled cleaning requires the product to be connected to be internet and will not be carried out if the network connection is unstable or disconnected.

### Zoned cleaning

Draw a cleaning zone and send the product to clean that specific area.

### Clean the specified target area

Mark specific points on a map for cleaning and the product will navigate to them automatically.

### Cleaning mode

Select Quiet, Balanced, Turbo or MAX mode. It is Balanced mode by default.

### Do Not Disturb (DND) mode

Any active cleaning cycle will stop, voice messages will not play, and the ring light drops to low brightness. This mode is enabled by default from 22:00 - 08:00 and can be disabled or adjusted.

### No-go Zones/Barrier tape

Set virtual no-go zones and barrier lines to prevent the product entering defied areas.

#### Notes:

- Map saving mode is required.
- This function should only be used to set cleaning areas, not to isolate hazardous areas.
- Moving the product or changing the home environment may result in a map failure or loss of the saved zones and barriers.

# Instructions for Use

## No-go Zones/Barrier tape

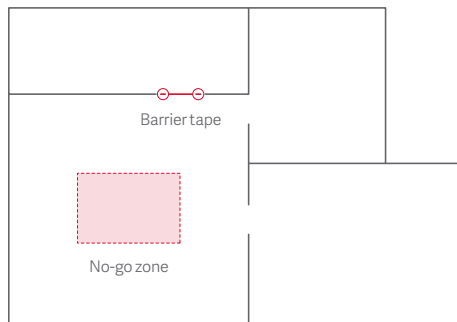

## More app functions

Real-time map update	Carpet pressurization mode	Product location
Suction control	Cleaning duration	Xiaomi Home smart devices
View cleaning logs	Remote control	Do Not Disturb mode
Voice selection	View status	Firmware updates

### Note:

Functions and app details may change due to the continuous development and upgrading of the app. Refer to the app for details.

## Refilling the water tank or cleaning the mop cloth mid-clean

If refilling the water tank or cleaning the mop cloth during a clean, press any button to pause the cleaning cycle and remove the mop module. Refill the water tank or clean the mopping cloth and reinstall the mopping module then press the  button to continue the cleaning cycle.

## Charging dock

Place the charging dock on a level floor and keep at least 1.7ft (0.5m) on either side and at least 5ft (1.5m) in front of it and plug it in. For a better experience with the Xiaomi Home app, place the charging dock in range of WIFI.

**Note:** Do not expose the charging dock to direct sunlight, Do not block the location signal area of the charging dock as this may prevent the product from returning to charge automatically.

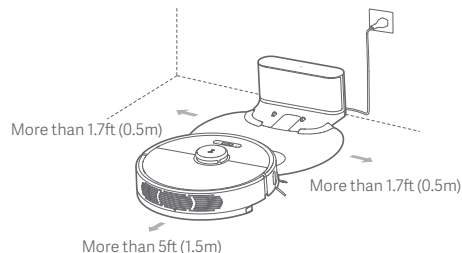

# Routine Maintenance

## Main brush \* Clean weekly

1. Flip the main unit over and push the latch to remove the main brush cover.
2. Lift the main brush out then remove and clean the bearing.
3. Rotate in the indicated unlock direction and remove the main brush cover.
4. Use the supplied brush cleaning tool to cut anything entangling the main brush or its bearing.
5. Re-install the main brush cover and the main brush bearing according to the lock direction.
6. Re-insert the the main brush and press the main brush cover back in until it is locked in place by the latch.

**Note:** Replacing the main brush every 6-12 months is recommended for maximum cleaning.

### Using the main brush cleaning tool

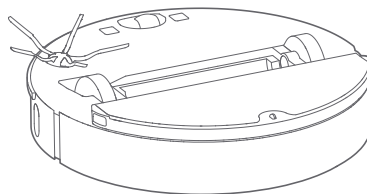
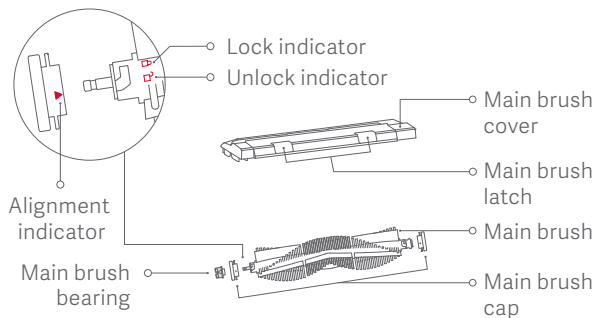
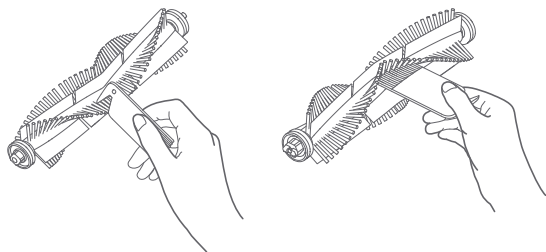

# Routine Maintenance

## Dustbin and filter \* Clean weekly

1. Open the top cover of the main unit and press the dustbin latch to release and remove the dustbin.

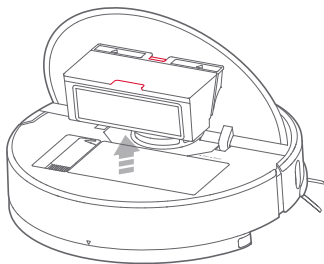

2. Open the dustbin cover as indicated by arrow and pour out the contents.

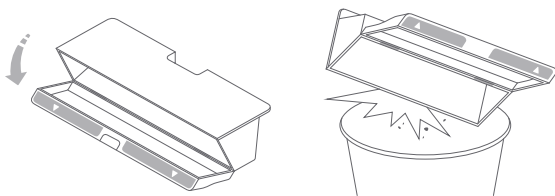

## Clean the filter \* Clean bi-weekly

1. Open the dust bin cover as indicated by the arrow.

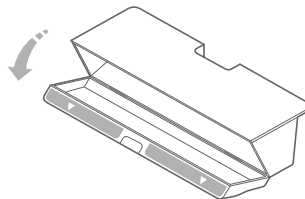

2. Fill the dustbin with clean water and close the cover. Shake the dustbin and pour out the dirty water.

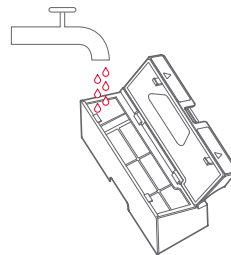

**Note:** Rinse with clean water without any detergent.



# Routine Maintenance

## Clean the filter \* Clean bi-weekly

3. Remove the filter and rinse with water.

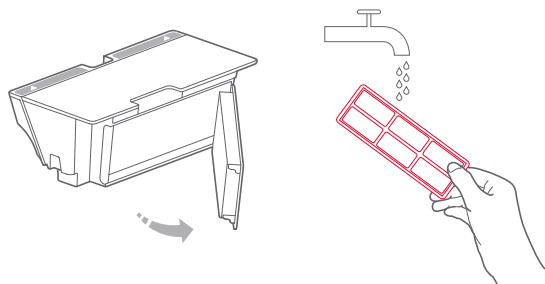

4. Rinse repeatedly and lightly tap the filter frame against a hard surface to shake loose any dirt. Continue until clean.

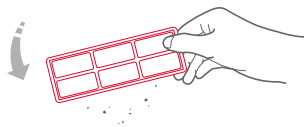

5. Dry the filter thoroughly and reinstall.

### Notes:

- Always dry the filter for at least 24-hours before use.
- Alternating between two filters is recommended.

## Battery

The product is equipped with a high-performance lithium-ion rechargeable battery. To maintain optimum battery performance, keep the main unit charged.

**Note:** If the main unit is to be left unused for a prolonged period of time, power it off before storage and charge it at least once every 3 months to avoid damaging the battery through over-discharging.

## Charging dock \* Clean monthly

Use a soft dry cloth to clean the charging contacts on the charging dock.

## Side brush \* Clean monthly

1. Flip the main unit over and remove the screws on the side brush unit.
2. Remove and clean the side brush.
3. Reinstall the side brush and tighten the screws.

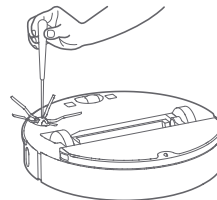

**Note:** Replacing the side brush every 3-6 months is recommended for maximum cleaning.

# Routine Maintenance

## Ordinary mop cloth \* Clean after use

1. Remove the mop cloth from the mopping module.

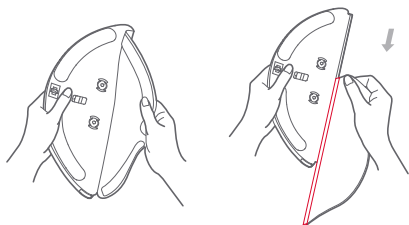

2. Clean the mopping cloth and dry it.

### Notes:

- Always remove the mop cloth for cleaning to avoid dirty water that may block the filter flowing into the water tank.
- If the mop cloth is too dirty, mopping may be affected. Clean it before use.
- Changing the mop cloth every 3-6 months is recommended for maximum cleaning.

## Disposable mopping cloth

Remove and discard used mop cloth, and replace it with a new one when required.

**Note:** Visit [www.roborock.com](http://www.roborock.com) to purchase additional disposable mop cloths.

## Filter assembly \* Replace every 1-3 months

1. Pull out the water filters as indicated.
2. Replace with new filters.



**Note:** Replacing filters every 1-3 months is recommended, depending on water quality and frequency of use, for maximum cleaning.

## Omni-directional wheel \* Clean monthly

1. Flip the main unit over and lift up the omni-directional wheel.
2. Remove any trapped hair and dirt on the wheel body and axle.
3. Reinstall the wheel body and press tightly in place.

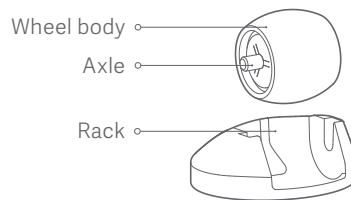

**Note:** The omni-directional wheel bracket cannot be removed.



# Routine Maintenance

## Reset system

If buttons are unresponsive or the main unit cannot be shut down, reset the system by pressing the Reset button (refer to page 10). The main unit will restart after reset.

 Resetting the system will reset the scheduled cleaning modes, WIFI, and other related settings.

## Restoring to factory defaults

If a problem persists after a system reset, power on the main unit then press and hold the  button. At the same time, press the Reset button. Keep holding the  button until you hear the “Start restoring initial version” voice prompt. The product will then restore all factory defaults.

## Firmware update

Use the Xiaomi Home app to update the firmware. Connect the main unit to the charging dock and ensure that the battery charge is at more than 20% before updating.

## Main unit sensors

Use a soft dry cloth to wipe and clean all sensors, including:

1. Six cliff sensors on the bottom.
2. One wall sensor on the right.
3. Charging contacts on the bottom.

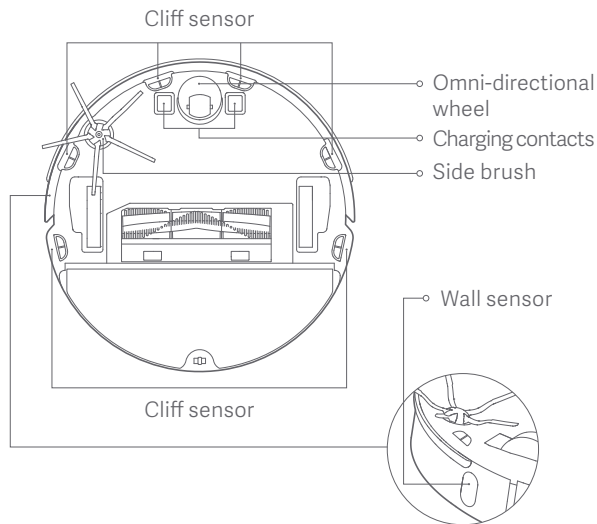

# Basic Parameters

## Main Unit

Name	Specs
Model	roborock S6
Dimensions	353×350×96.5 mm
Battery	14.4 V / 5200 mAh lithium battery
Weight	About 3.6 kg
Wireless connection	WIFI direct connect
Voltage rating	14.4 VDC
Power rating	58 W

## Charging Dock

Name	Specs
Model	CDZ08RR or CDZ09RR
Dimensions	160×232×116 mm
Power rating	42 W
Input rating	100-240 VAC
Output rating	20 VDC 1.8 A
Frequency rating	50-60 Hz

# Troubleshooting

When a runtime error occurs, the power light flashes red quickly and a voice prompt is given. Please use the table below to solve the problem.

Fault display	Solution
Error 1: Turn the laser unit and check that it is not jammed or blocked.	The laser is stuck or has been blocked. Remove any blockages and retry. If the problem persists, move the main unit to a new location and restart it.
Error 2: Clean and lightly tap the bumper.	The bumper is stuck. Lightly tap the bumper to remove any blockages. If no blockages are found, move the main unit to a new location and restart it.
Error 3: Move the main unit to a new location and restart.	A wheel is not in contact with the ground. Move the main unit to a new location and restart it.
Error 4: Clean cliff sensors, move the main unit away from any drops, then restart.	The main unit is on standby. Move it to a new location and restart it. This problem may be caused by a dirty cliff sensor. Wipe sensor and retry.
Error 5: Remove and clean the main brush and brush bearing.	The main brush may have become tangled. Remove and clean it and its bearing.
Error 6: Remove and clean the side brush.	The side brush may have become entangled. Remove it for cleaning.
Error 7: Check that wheels are not blocked, then move the main unit to a new location and restart.	The main wheel may have become entangled. Remove it and restart the main unit.
Error 8: Remove any obstacles around the main unit.	The main unit may be stuck or caught on an obstacle. Clear any obstacles around it.
Error 9: Reinstall dustbin and filter.	Reinstall the dustbin and filter and check that they are installed correctly. If the problem persists, try replacing the filter.

# Troubleshooting

Error 10: Check the filter. If wet, use a dry one. If dry, clean it and try again.	The filter is not completely dry. Dry it for at least 24 hours before use. The filter may be blocked. Clean it and restart. If the problem persists, replace the filter.
Error 11: Strong magnetic field detected. Move the device away from barrier tape and restart.	The main unit is too close to a barrier tape at startup. Move it and restart.
Error 12: Battery level too low. Recharge before use.	Low battery. Charge before use.
Error 13: Charging error. Cleaning charging contacts and try again.	Use a dry cloth to wipe main unit and charging dock charging contacts.
Error 14: Battery error.	The battery temperature is too high or too low. Wait until the battery temperature returns to normal before use.
Error 15: Clean wall sensor.	The wall sensor is blocked by dust. Wipe clean the sensor.
Error 16: Place and start the main unit on a level floor.	The main unit is starting on an incline. Place it on level ground and restart.
Error 17: Side brush module error. Reset the main unit.	A malfunction has occurred with the side brush module. Reset the system and try again.
Error 18: Fan error. Reset the main unit.	A malfunction has occurred with the vacuum cleaner fan. Reset the system and try again.
Error 21: Height sensor has been pressed. Move the main unit and restart.	The height sensor has been pressed or is stuck. Move the main unit to a new location and restart.
Error 22: Clean the recharge sensor on the main unit	The recharge sensor is blocked by dust. Wipe clean the sensor.
Error 23: Clean the transmission area on the charging dock.	The charging dock is obstructed. Clear the obstruction.
Internal error. Please try resetting the system.	Malfunction due to an internal error. Reset the system.

**Note:** Resetting the system may solve some problems.

If the problem persists after using the recommendations in the table above, please email our after-sales service team:

US/Non-Europe Support: [support@roborock.com](mailto:support@roborock.com) Europe Support: [support@roborock-eu.com](mailto:support@roborock-eu.com)

## FAQs

Problem Type	Solution
Unable to power on	The battery level is low. Please put the main unit back onto the charging dock to charge it before use. Battery temperature is too low or too high. Please use the main unit in the range of 39°F (4°C) ~ 104°F (40°C).
Unable to charge	The charging dock is not plugged in. Please confirm the two ends of the power cable are properly plugged. Contact is poor. Please clean the contact tab on the charging dock and the charging contact on the main unit. Please confirm whether the charging indicator is on.
Slow charging speed	When used at high or low temperatures, the main unit will automatically reduce the charging speed so as to extend battery life. The charging contact areas may be dirty. Please use a dry cloth to clean such areas.
Unable to recharge	There are too many obstacles near the charging dock. Please place it in an open area. The main unit is too far from the charging dock. Please put it near the charging dock.
Abnormal behavior	Please power off and on the main unit.
Noise during cleaning	The main brush, side brush, Omni-directional wheel or main wheel may be entangled with foreign matters. Please clean them off after powering off.
Cleaning capacity decreased or dust dropped out	The dustbin is full. Please empty it. The filter is blocked. Please clean it. The main brush is entangled with foreign matters. Please clean them off.
Unable to connect to WIFI	WIFI is disabled. Please reset the WIFI and try again. WIFI signal is poor. Please make sure that the main unit is in an area with good WIFI signal reception. Abnormal WIFI connection: Please reset WIFI and download the latest mobile app to retry connecting.

## FAQs

Scheduled cleaning is not working	The battery level is low. Scheduled cleaning can start only if the battery level is above 20%.
Is the battery being drained if the main unit sits on the charging dock?	The battery usage is extremely low when the main unit sits on the charging dock, which helps maintain optimal battery performance.
Do I need to charge the battery for at least 16 hours for the first three uses?	The lithium battery has no memory effect, so it's okay to just fully charge it.
No or little water during mopping	Please check whether there is water in the water tank, adjust to water volume switch to high, rinse the mopping cloth, replace the filter, or follow the instructions in the user manual to correctly install the mopping cloth.
Too much water during mopping	Please make sure that the water tank cover and the filter are properly installed in place, and adjust the water volume switch to low.
Cleaning does not resume after recharging	Please make sure that the main unit is not in Do Not Disturb mode, as cleaning cannot resume in this mode. Cleaning resumption is not available in the case of manual recharge or putting the main unit onto the charging dock.
Unable to return to the dock charger after spot cleaning or position change	The main unit will re-generate a map after spot cleaning or a significant position change. If the charging dock is far away, the main unit may not be able to automatically return for recharge. Please put it onto the charging dock manually.



# EU Declaration of Conformity

Hereby we:

Name of manufacturer	Beijing Roborock Technology Co.,Ltd.
Address	Floor6, Suite6016, 6017, 6018, BuildingC, Kangjian Baosheng Plaza, No.8 Heiquan Road, Haidian District, Beijing, P.R.CHINA

declare that this DoC is issued under our sole responsibility and that the products:

Product description	Robotic Vacuum Cleaner and Accessories
Type(model) designation(s)	roborock S6

are in conformity and verified through testing with the provision of the following EU directives:

RED Directive 2014/53/EU Article 3.1 a): Safety&Health 1. EN 60335-1:2012 + A11:2014 + AC:2014 + A13:2017 2. EN 60335-2-2:2010 + A11:2012 + A1:2013 3. EN 62311:2008 4. EN 62233:2008	1.Household and similar electrical appliances-Safety-Part 1: General requirements 2.Household and similar electrical appliances-Safety-Part 2-2: Particular requirements for vacuum cleaners and water suction cleaning appliance 3.Assessment of electronic and electrical equipment related to human exposure restrictions for electromagnetic fields (0 Hz - 300 GHz) 4.Measurement methods for electromagnetic fields of household appliance and similar apparatus with regard to human exposure
---	---

## EU Declaration of Conformity

<p>RED Directive 2014/53/EU Article 3.1 b): EMC</p> <ol style="list-style-type: none"> <li>1. Draft EN 301 489-1 V2.2.0</li> <li>2. Draft EN 301 489-17 V3.2.0</li> <li>3. EN 55014-1:2017</li> <li>4. EN 55014-2: 2015</li> <li>5. EN 61000-3-2: 2014</li> <li>6. EN 61000-3-3: 2013</li> </ol>	<ol style="list-style-type: none"> <li>1. Electromagnetic Compatibility (EMC) standard for radio equipment and services; Part 1: Common technical requirements; Harmonized Standard covering the essential requirements of article 3.1(b) of Directive 2014/53/EU and the essential requirements of article 6 of Directive 2014/30/EU</li> <li>2. Electromagnetic Compatibility (EMC) standard for radio equipment and services; Part 17: Specific conditions for Broadband Data Transmission Systems; Harmonized Standard covering the essential requirements of article 3.1(b) of Directive 2014/53/EU</li> <li>3. Electromagnetic Compatibility-Requirements for household appliances, electric tools and similar apparatus Part 1: Emission</li> <li>4. Electromagnetic compatibility – Requirements for household appliances, electric tools and similar apparatus Part 2: Immunity – Product family standard</li> <li>5. Electromagnetic compatibility (EMC) - Part 3-2: Limits - Limits for harmonic current emissions (equipment input current <math>\leq 16</math> A per phase).</li> <li>6. Electromagnetic compatibility (EMC) - Part 3-3: Limits - Limitation of voltage changes, voltage fluctuations and flicker in public low-voltage supply systems, for equipment with rated current <math>\leq 16</math> A per phase and not subject to conditional connection.</li> </ol>
<p>RED Directive 2014/53/EU Article 3.2: Radio Spectrum EN 300 328 V2.1.1</p>	<p>Wideband transmission systems; Data transmission equipment operating in the 2,4 GHz ISM band and using wide band modulation techniques; Harmonized Standard covering the essential requirements of article 3.2 of Directive 2014/53/EU</p>
<p>RoHS Directive 2011/65/EU EN50581:2012</p>	<p>Technical documentation for the assessment of electrical and electronic products with respect to the restriction of hazardous substances</p>

<p>Product description</p>	<p>Charging Dock and Accessories</p>
<p>Type(model) designation(s)</p>	<p>Charging Dock , models: CDZ08RR or CDZ09RR.</p>

are in conformity and verified through testing with the provision of the following EU directives:

# EU Declaration of Conformity

<p>Low Voltage Directive 2014/35/EU</p> <ol style="list-style-type: none"><li>1. EN 60335-1:2012 + A11:2014</li><li>2. EN 60335-2-29:2004 + A2:2009</li><li>3. EN 62233:2008</li></ol>	<ol style="list-style-type: none"><li>1. Household and similar electrical appliances-Safety-Part 1: General requirements</li><li>2. Household and similar electrical appliances-Safety-Part 2-29: Particular requirements for battery chargers</li><li>3. Measurement methods for electromagnetic fields of household appliance and similar apparatus with regard to human exposure</li></ol>
<p>EMC Directive 2014/30/EU</p> <ol style="list-style-type: none"><li>1. EN 55014-1:2017</li><li>2. EN 55014-2: 2015</li><li>3. EN 61000-3-2: 2014</li><li>4. EN 61000-3-3: 2013</li></ol>	<ol style="list-style-type: none"><li>1. Electromagnetic Compatibility-Requirements for household appliances, electric tools and similar apparatus Part 1: Emission</li><li>2. Electromagnetic compatibility – Requirements for household appliances, electric tools and similar apparatus Part 2: Immunity – Product family standard</li><li>3. Electromagnetic compatibility (EMC) - Part 3-2: Limits - Limits for harmonic current emissions (equipment input current <math>\leq 16</math> A per phase).</li><li>4. Electromagnetic compatibility (EMC) - Part 3-3: Limits - Limitation of voltage changes, voltage fluctuations and flicker in public low-voltage supply systems, for equipment with rated current <math>\leq 16</math> A per phase</li></ol>
<p>RoHS Directive 2011/65/EU EN50581:2012</p>	<p>Technical documentation for the assessment of electrical and electronic products with respect to the restriction of hazardous substances</p>

Person responsible for making this declaration:

Printed name: Rui.Shen

Position/Title: Quality Director

Signature: *Rui Shen*

Date of issue: Jun 14, 2018

Place of issue: Floor 6, Suite 6016, 6017, 6018, Building C, Kangjian Baosheng Plaza,  
No. 8 Heiquan Road, Haidian District, Beijing, P.R. CHINA

## WEEE Information

Correct Disposal of this product . This marking indicates that this product should not be disposed with other household wastes throughout the EU. To prevent possible harm to the environment or human health from uncontrolled waste disposal, recycle it responsibly to promote the sustainable reuse of material resources. To return your used device, please use the return and collection systems or contact the retailer where the product was purchased. They can take this product for environmental safe recycling.

Korrekte Entsorgung dieses Produkts Innerhalb der EU weist dieses Symbol darauf hin, dass dieses Produkt nicht über den Hausmüll entsorgt werden darf. Altgeräte enthalten wertvolle recyclingfähige Materialien, die einer Wiederverwertung zugeführt werden sollten und um der Umwelt bzw. der menschlichen Gesundheit nicht durch unkontrollierte Müllbeseitigung zu schaden. Bitte entsorgen Sie Altgeräte deshalb über geeignete Sammelsysteme oder senden Sie das Gerät zur Entsorgung an die Stelle, bei der Sie es gekauft haben. Diese wird dann das Gerät der stofflichen Verwertung zuführen.



# Warranty Information

## Warranty Information

The seller provides warranty in accordance with the legislation of the customer's own country of residence, with a minimum of 1 year, starting from the date on which the appliance is sold to the end user.

The warranty only covers defects in material or workmanship.

The repairs under warranty may only be carried out by an authorized service centre. When making a claim under the warranty, the original bill of purchase (with purchase date) must be submitted.

The warranty will not apply in cases of:

Normal wear and tear

Incorrect use, e.g. overloading of the appliance, use of non-approved accessories Use of force, damage caused by external influences Damage caused by non-observance of the user manual,

e.g. connection to an unsuitable mains supply or non-compliance with the installation instructions

Partially or completely dismantled appliances.

## Laser Safety

The laser distance sensor of this product meets the standards for Class I Laser Products in IEC 60825-1:2014 and will not generate hazardous laser radiation.