

Mi Bedside Lamp 2

User Manual



Product Overview

Read this manual carefully before use, and retain it for future reference.

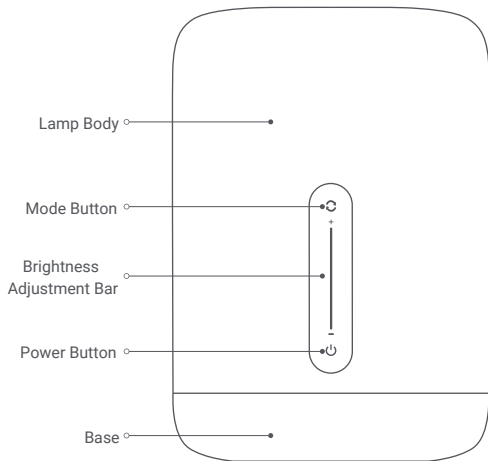

Thank you for using this product. The Mi Bedside Lamp 2 uses high-quality LED chips with a professional optical structure, combined with a natural light mixing algorithm, excellently bringing out the light of various colors and offering you the different colors you want. Moreover, it provides a newly designed high-tech feeling touch control.

Using the Lamp

Installation

Plug the power cable into the charging port at the base and connect the adapter to a power supply.

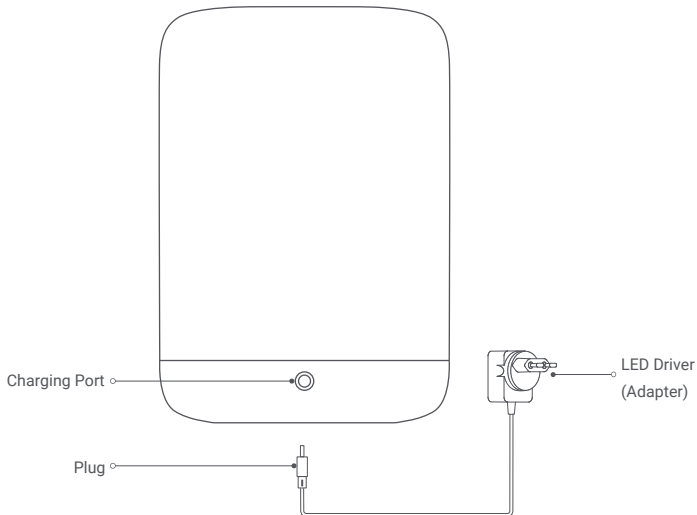

* It is recommended that you place it on a nightstand or a desk.

Instructions

01 Function Buttons

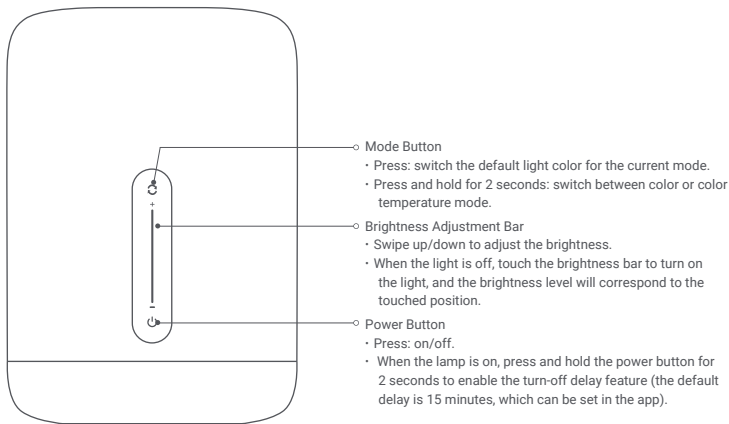

02 Advanced Features

Night Light Function

You can set the time period via the mobile app to enable the night light mode. When turning on the lamp with the night light mode enabled, the lamp will automatically enter into night light mode to avoid excessive brightness to the eyes. When turning on the lamp during non-night light periods, the lamp will automatically return to the state saved in normal mode.

03 Connect with Mi Home / Xiaomi Home App

This product works with Mi Home / Xiaomi Home app *. Control your device, and interact it and other smart home devices with Mi Home / Xiaomi Home app.

Scan the QR code to download and install the app. You will be directed to the connection setup page if the app is installed already. Or search "Mi Home / Xiaomi Home" in the app Store to download and install it.

Open Mi Home / Xiaomi Home app, tap "+" on the upper right, and then follow prompts to add your device.

* The app is referred to as Xiaomi Home app in Europe (except for Russia). The name of the app displayed on your device should be taken as the default.



Note:



The version of the app might have been updated, please follow the instructions based on the current app version.

04 Apple HomeKit Smart Control

1. Open the Home app on your iPhone or iPad.
 2. Tap "Add Accessories" and follow the instructions in the app to scan the QR code on the product base, or enter the 8-digit setup code above the QR code to grant the Apple Home app access.
- * Make sure a Wi-Fi network with Internet access is available (this product does not support 5G networks). To control this HomeKit-compatible accessory, it is recommended that you use iOS 9.0 or above. The HomeKit setup code is listed on the product base, do not lose it. After restoring factory settings, you will need the HomeKit setup code again to add the accessory.
- iPad and iPhone are the trademarks of Apple Inc., and they are registered in the United States and other countries.

05 Link a Lamp with Google Assistant

Add the Mi Home / Xiaomi Home service to the Google Assistant app, to control devices connected to Mi Home / Xiaomi Home from Google Assistant.

1. Tap  in the Google Assistant app, search for "Mi Home / Xiaomi Home", tap "Link", and sign in with your Xiaomi account.
2. Tap  in Settings > Home control to add a device, and follow the on-screen instructions. Once the accounts are linked, you can control the Lamp from Google Assistant.

06 Link a Lamp with Amazon Alexa

Add the Mi Home / Xiaomi Home skill to the Amazon Alexa app, to control devices connected to Mi Home / Xiaomi Home from Amazon Alexa.

1. Tap  in the Amazon Alexa app, then tap "Skills & Games", search for "Mi Home / Xiaomi Home", select the correct skill and tap "Enable". Then sign in with your Xiaomi account.
2. After successfully linking the accounts, tap DISCOVER DEVICES to add the device, and follow the on-screen instructions. Once the accounts are linked, you can control the Lamp from Amazon Alexa.

Note: The name (Mi Home or Xiaomi Home) varies by selected language or regions.

Specifications

Name: Mi Bedside Lamp 2

Model: MJCTD02YL

Operating Temperature: -10 ~ 35°C

Operating Humidity: 0% - 85% RH

Compatible with: Android 4.4 or iOS 9.0 and above

Wireless Connectivity: Wi-Fi IEEE 802.11 b/g/n 2.4 GHz

Operating Frequency: 2412 - 2472 MHz (Wi-Fi)

2402 - 2480 MHz (BT)

Adjustable Color: WRGB

Color Rendering Index: Ra80

Power Factor: 0.5

Bedside Lamp Input: 12 V $\overline{\text{---}}$ 0.8 A $\overline{\text{---}}$ $\overline{\text{---}}$

Rated Input: 220-240 V~50/60 Hz 0.45 A

Rated Power: 9 W (Lamp + LED Driver)

Maximum Output Power: 17.91 dBm (Wi-Fi)

5.76 dBm (BT)

Product Features



Adjustable
Color



Adjustable Color
Temperature



Adjustable Brightness



Night Light



Flowing Light



Touch Interaction



Scheduled On/Off



Turn-off Delay



Pick Color



Mi Home App
Control



Apple HomeKit
Control



Smart Control

Restore Factory Settings

Simultaneously press and hold the power button and mode button for 5 seconds, until the lamp starts circulating through the colors red, green and blue, then release the buttons. After the circulating colors end, the lamp will automatically restart, and restoring factory settings will be completed.

* When using the bedside lamp in a new network environment, you need to restore factory settings and connect to the network again.

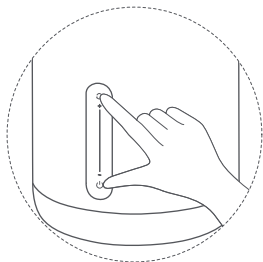

Precautions

- Make sure the voltage is consistent with the product's working voltage before use. Using the incorrect voltage may damage the product and cause a potential safety hazard.
- The light source of this lamp is irreplaceable. When the light source reaches the end of its service life, the entire lamp needs to be replaced. Do not disassemble this product.
- The lamp will produce heat during operation, please use it in a well-ventilated area so that heat can dissipate.
- Do not use non-standard adapters to avoid product damage or safety hazards.
- Place the lamp steadily and do not tip it over during use.

CE EU Declaration of Conformity

Hereby, Qingdao Yeelink Information Technology Co., Ltd., declares that the radio equipment type MJCTD02YL is in compliance with Directive 2014/53/EU. The full text of the EU declaration of conformity is available at the following internet address: <https://www.mi.com/en/service/support/declaration.html>.

WEEE Disposal and Recycling

All products bearing this symbol are waste electrical and electronic equipment (WEEE as in directive 2012/19/EU) which should not be mixed with unsorted household waste. Instead, you should protect human health and the environment by handing over your waste equipment to a designated collection point for the recycling of waste electrical and electronic equipment, appointed by the government or local authorities. Correct disposal and recycling will help prevent potential negative consequences to the environment and human health. Please contact the installer or local authorities for more information about the location as well as terms and conditions of such collection points.



Manufactured for: Xiaomi Communications Co., Ltd.

Manufactured by: Qingdao Yeelink Information Technology Co., Ltd.

(a Mi Ecosystem company)

Address: F10-B4, Bldg. B, International Innovation Park, 1# Keyuanweiyi Rd.,

Laoshan District, Qingdao, 266101, Shandong, China

For further information, please go to www.mi.com

Importer:

Beryko s.r.o.

Na Roudné 1162/76, 301 00 Plzeň

www.beryko.cz